

1

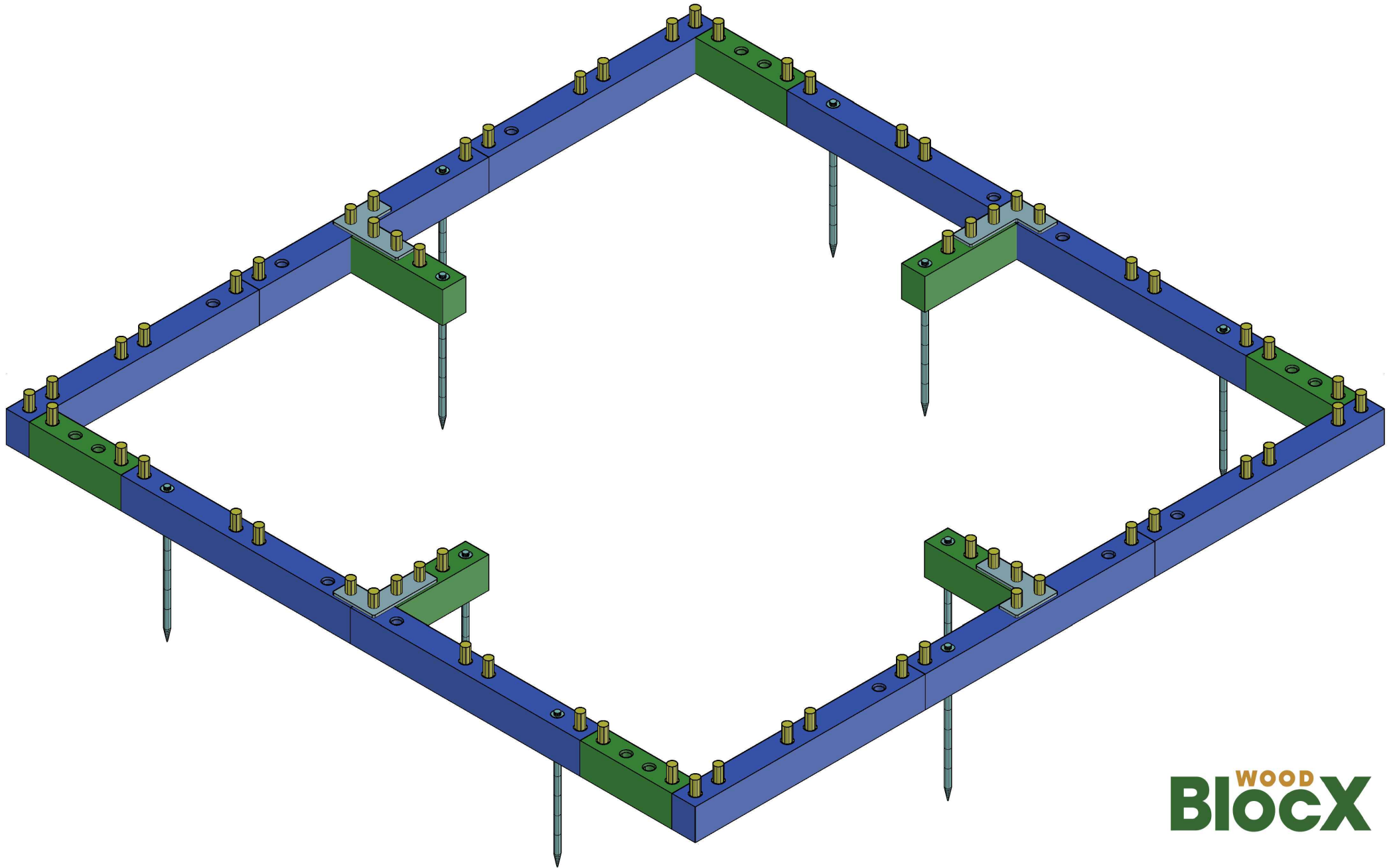

2

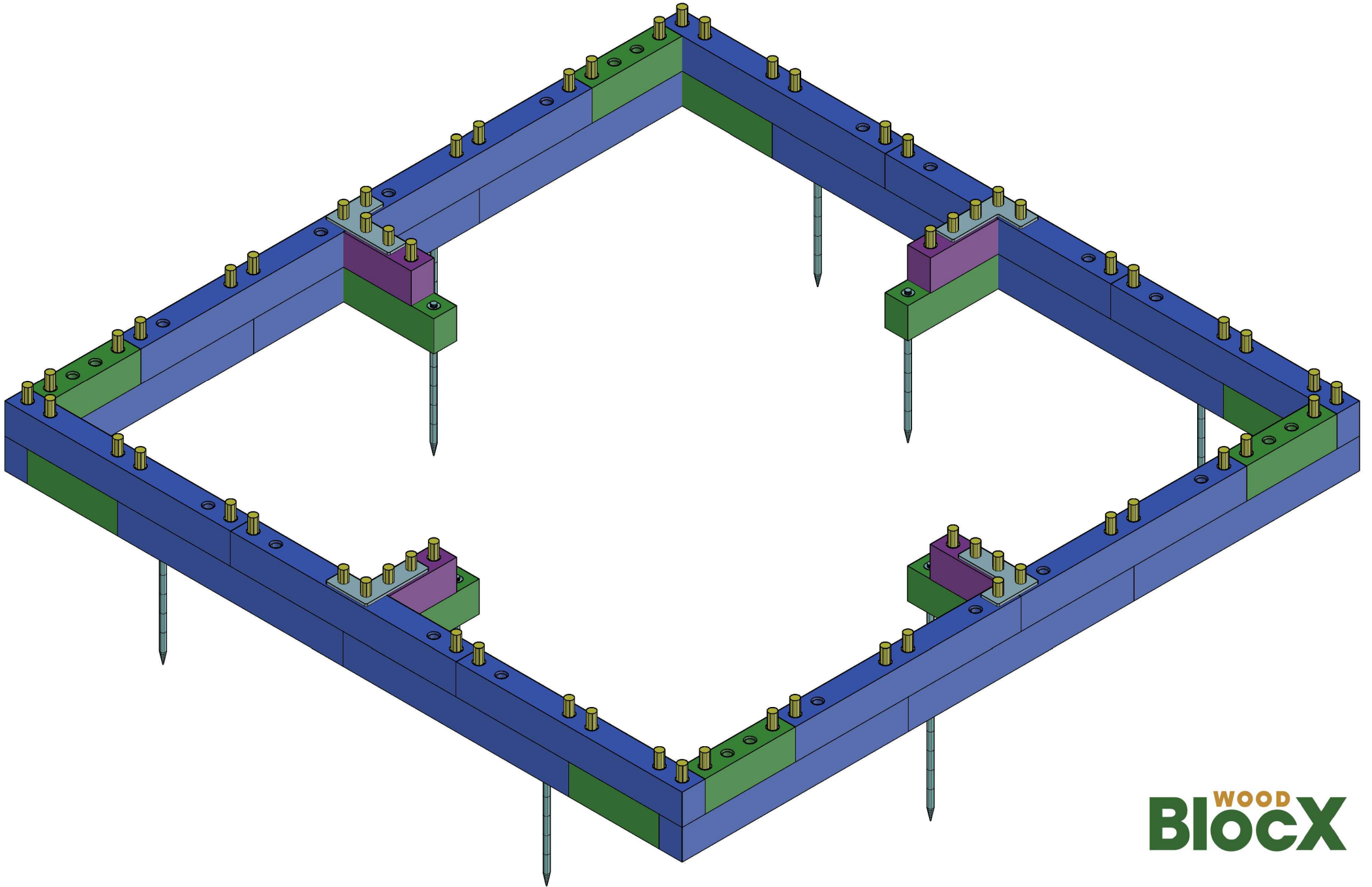

3

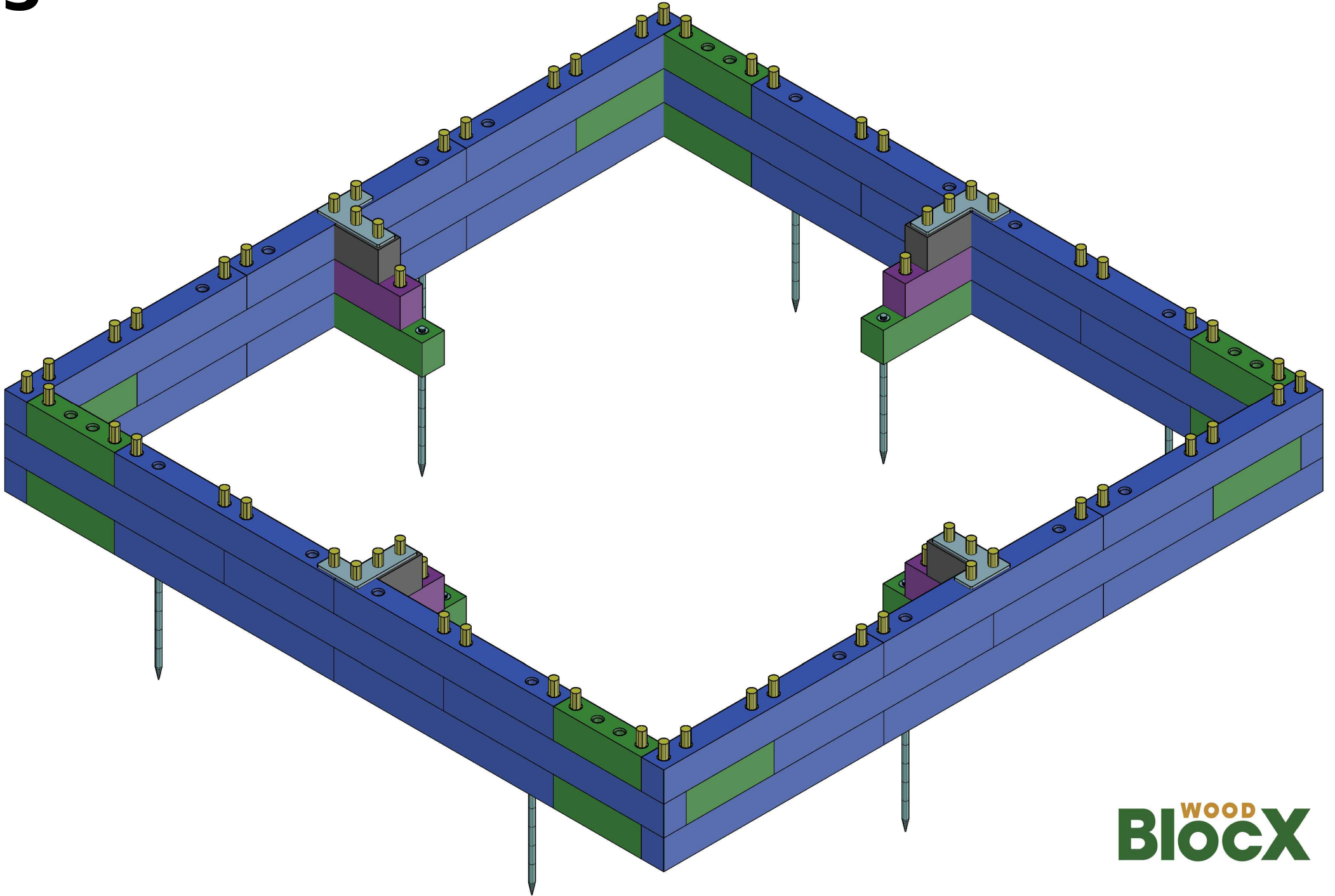



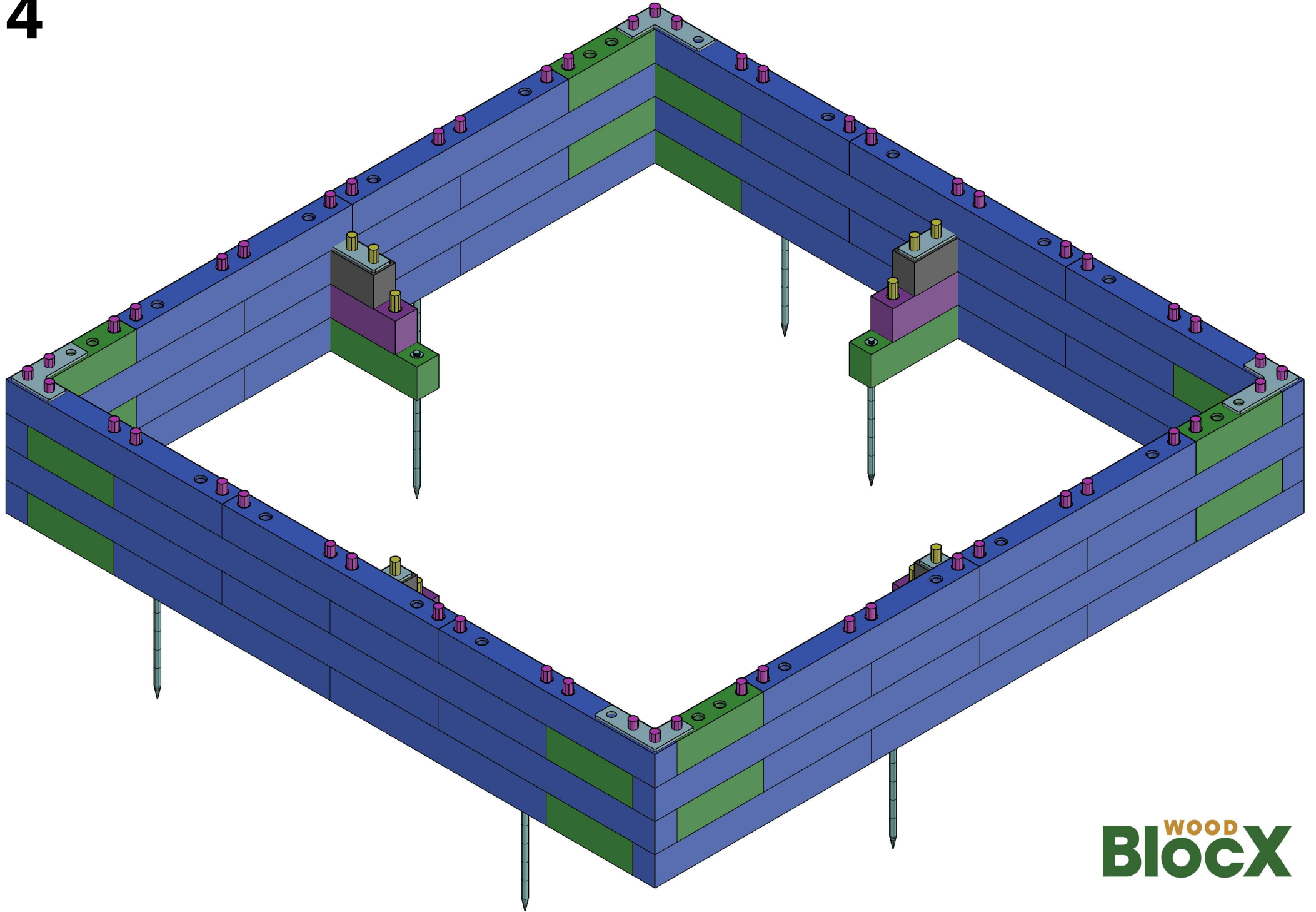



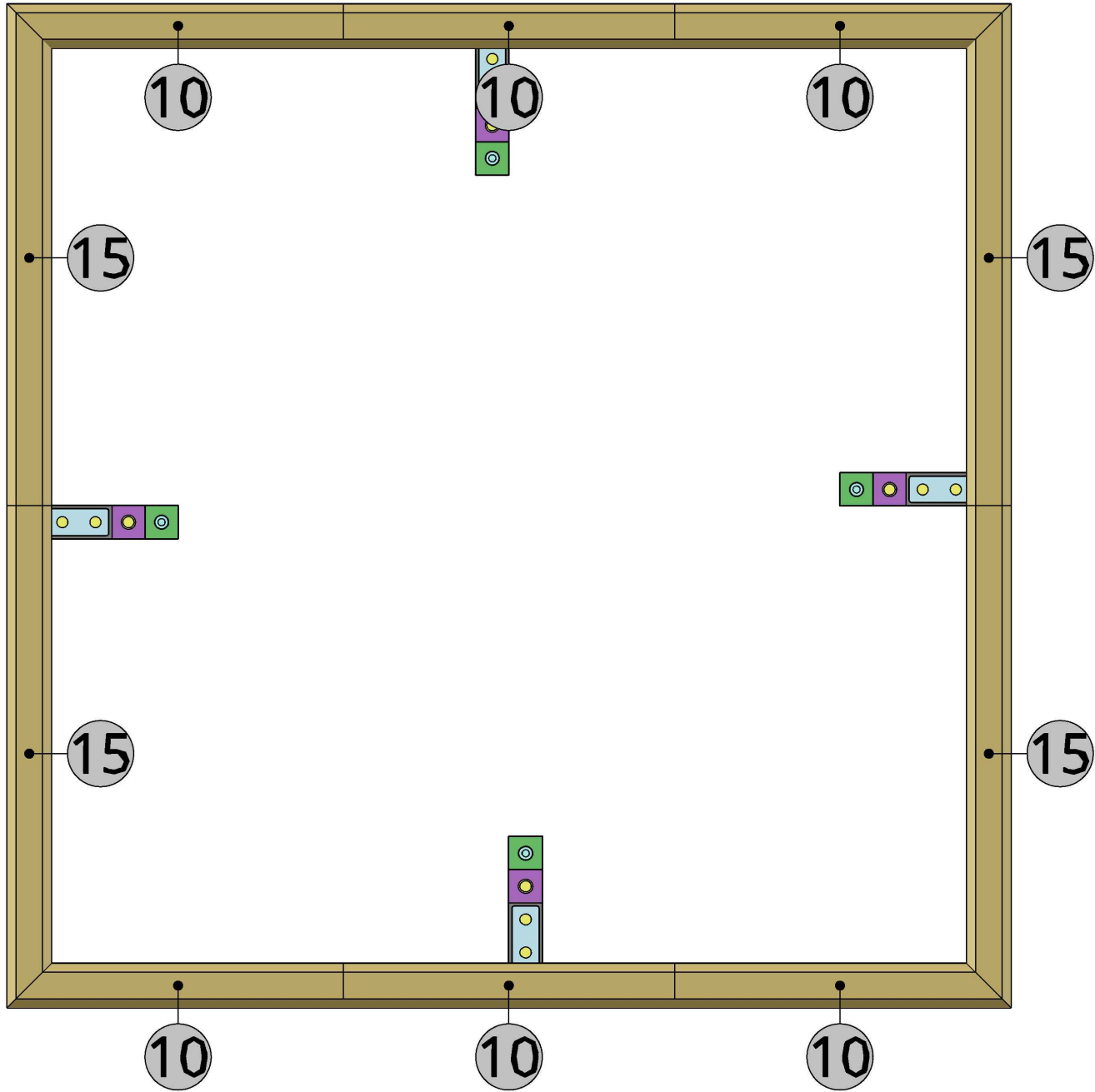



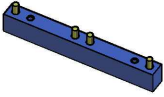



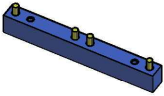

4

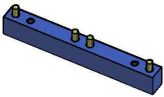

5

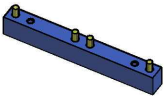

6

1	 10	 8		 10	 64	 4	
2	 10	 4	 4		 64	 4	
3	 10	 4	 4		 60	 4	
4	 10	 4				 4	 52